

# Commercial Ice Makers

## USER INSTALLATION & MAINTENANCE MANUAL

The logo for OSION, featuring a stylized blue 'O' with horizontal lines on the left, followed by the word 'SION' in a bold, blue, sans-serif font.

**OSION MODULAR MODELS: OCM-350, OCM-500, OCM-1000**



[www.mvpgroupcorp.com](http://www.mvpgroupcorp.com)



3560 NW 56th Street  
Fort Lauderdale, FL 33309  
Tel.: 786.600.4687 / Toll Free: 844.218.8477  
Fax.: 786.661.4100



5659 Royalmount Avenue  
Montreal, Qc, Canada H4P 2P9  
Tel.: 514.737.9701 / Toll Free: 888.275.4538  
Fax.: 514.342.3854 / Toll Free: 877.453.8832

[sales@mvpgroupcorp.com](mailto:sales@mvpgroupcorp.com)

# Contents

## Safety information

Warning information .....	1
Caution information .....	2

## Installation information

Unpacking .....	2
Water supply and ambient temperature.....	2
Electrical .....	4
Pre-start up Check.....	5

## Operating instruction

Digital & indicator display and controller .....	6
Ice production .....	7
Ice harvest .....	7
Standby.....	7
Ice full.....	7
Water clean.....	8
How to set delay to resume ice production.....	8
How to set up ice making cycle time.....	8

## Maintenance & Cleaning

Exterior cleaning.....	9
Air filter cleaning .....	10
Condenser cleaning .....	10
Water distributor, water tank and float switch cleaning.....	10

## Trouble shooting

Trouble shooting.....	11
Wiring diagram.....	13

## **Safety information**

Before using your ice machine, please read this manual thoroughly to ensure that you know how to operate the features and functions that the equipment offers safely and efficiently.

### **Important safety symbols and precautions:**

Please read and always follow all safety instructions in this manual.



This is the safety alert symbol.

This symbol alerts you to potential hazards that can kill or hurt you and others.

All safety messages will follow the safety alert symbol and either the word "DANGER" or "WARNING"

**⚠ DANGER**

Hazard or unsafe practices that may result in severe personal injury, property damage or death.

**⚠ WARNING**

Hazard or unsafe practices that may result in severe personal injury, property damage or death.

The warning signs are here to prevent injury to you and others, please follow them explicitly. After reading this manual, keep it in a safe place for further reference.



### **Warning information**

- 1- Read this instructions carefully before operating, installation or maintenance. Failure to follow instruction can cause your personal injury, and property damage, injury or death.
- 2- This ice machine is intended for indoor use only, do not install or operate this ice machine in outdoor areas.
- 3- Installation, repairs or maintenance must be performed by certificated and properly trained technicians.
- 4- At least three persons are required to lift the ice machine; or it is recommended that a lifting device is used to avoid injury.
- 5- When moving this ice machine, please keep the unit upright with inclination not exceeding 45° degrees. Do not invert the unit or lay it down horizontally.
- 6- In order to keep the lubricant be fully precipitated before start up, please keep the machine upright for a minimum of 24 hours before plugging, otherwise the compressor may be damaged.
- 7- Allow sufficient space (minimum clearance of 15mm) around the ice maker and install it on a flat surface to support the full weight of the ice machine when loaded with ice and water.
- 8- Do not keep any flammable objects or liquids in or near to the ice machine.
- 9- Do not use high-pressure water cleaning devices to clean the ice machine.

- 10- Do not install the ice machine in a damp location where it may come in contact. Deteriorated insulation on electrical parts may cause an electric shock or fire.
- 11- In order to keep the lubricant be fully precipitated before start up, please keep the machine upright for a minimum of 24 hours before plugging, otherwise compressor may be damaged.



### Danger information

- 1- The ice machine may contains flammable refrigerant R-290 that risk of fire, explosion, contact your local authority in regard to safe disposal of this product. Please check the nameplate on the rear panel of machine to identify the type of refrigerants to confirm the refrigerant type.
- 2- To minimize the risk of ignition due to improper installation, replacement part or service procedures, only certified and properly trained refrigeration technicians are licensed and insured to repair these ice machines.

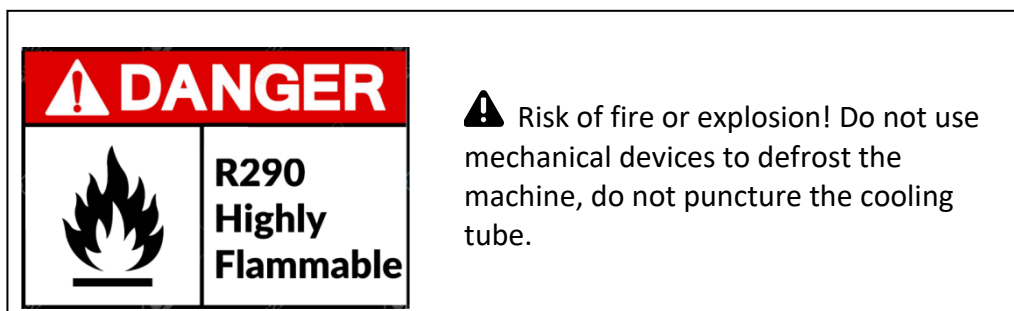

- 3- Do not operate the ice machine if there are any unauthorized changes to the original manufacturer specifications; or if the ice machine has been misused, abused or neglected.
- 4- All replacement parts must be Original Equipment Manufacturer (OEM) and obtained from the equipment manufacturer (MVP Group).
- 5- Due to potential safety hazard risk, make sure that the power plug is not bent, or damaged; and never use any power extension cordsets.

### Installation information

#### Unpacking

- Carefully remove all shipping material such as wrapping, tape and packing. If any is left in the ice head and ice bin, it will cause the ice machine to work improperly. (Make sure the packing is in good condition before unpacking.)
- After removing all the packing materials, make sure the machine, bin and all components are good condition. If in any doubt, do not install or connect the ice machine and must report to your supplier immediately.
- Put the ice bin on the floor and screw the four adjustable feet of the attachment into the bin completely for leveling. A level should be used to check if the machine is perfectly level. Then place the ice head onto the top of the ice bin.

### Water supply and ambient temperature

1- The water used for the ice machine must be in accordance with local drinking water quality standards. We recommend installation of an incline water filter to the ice machine, this will reduce limescale build up, improve efficiency and extend the overall lifespan of the machine.

2- Water supply pressure should be between 0.2psi and 0.8psi. If pressure exceeds 0.8psi, a pressure reducing level must be used.

3- **⚠** Water inlet temperature should be between **40°F and 77°F** (5°C and 25°C). Any faults due to low or high water pressure and temperature are not covered under this warranty.

4- **⚠** The ice maker drain is of gravity flow, make sure the unit is installed above the height of the drain connector and make sure the hose is not bent to allow for proper easy drainage.

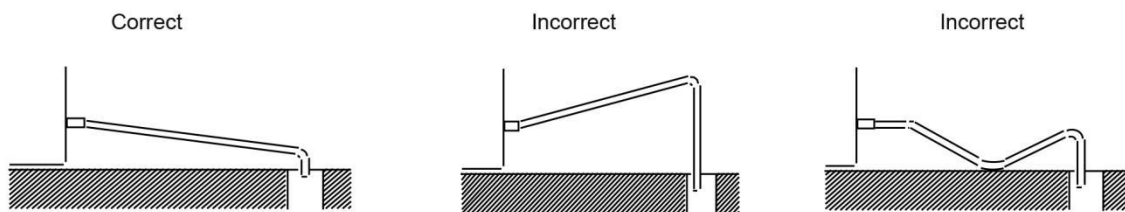

5- Attach one end of the water inlet hose to the rear of the ice machine, attach the other end of the hose to the water supply. It is advisable to have a stop valve close to the ice machine.

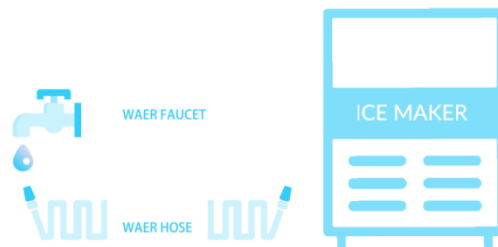

6- Check both connector washer for proper fit.

7- Put the flexible drain hose on the drain connector at the rear of the machine and secure with clip provided. The drain pipe can be cut to length to allow drain connection to have a slight fall if necessary.

8- It is recommended that water supply and drain lines be insulated to prevent condensation.

9- **⚠** Ambient temperature for the ice machine operation should between 40°F - 104°F (5°C - 40°C).

Inlet water temperature	Water pressure	Internal diameter of water inlet pipe	Drain pipe
40° - 90° F.	0.2psi~0.8psi	Internal diameter 3/4" connector	Internal diameter 3/4" connector

## Electrical

1-  The ice machine must be plugged into an independent power source or an electrical socket of voltage and frequency specified. Electrical rating information can be found on the name plate of the machine. Do not operate this machine above or below the voltage specified on the machine name plate; otherwise you shall void the manufacturer warranty.

 **Warning**

All electrical connections must conform to local regulations and be carried out by a qualified installer/engineer.

 **Warning**

If the power supply is damaged, do not install or operate the ice machine until the cable has been replaced by an authorized service partner or a qualified electrician.

2-  Due to potential safety hazards this ice machine is not recommended for use with a power extension cordset.

3-  This ice machine must be connected to the stability power, maximum accept range of the voltage fluctuation is +10%, -5% than the rated voltage.

 **Warning**

If the ice machine is turned off, please wait for at least 3 minutes before restarting to prevent damage to the compressor.

## 4- Electric Specification

MODEL	VOLTAGE	WATTS	AMP LOAD
OCM-350	115 60Hz	800W	9.5A
OCM-500	115 60Hz	940W	10A
OCM-1000	208-220Hz	2080W	10A

## Pre-start up checklist

- 1- Has the unit been connected to the proper water supply and no leaks?
- 2- Has the unit been connected to a drain and no leaks?
- 3- Has the unit connected to the proper electrical supply?
- 4- Has the unit been leveled?
- 5- Have all packing materials been removed from the ice machine?
- 6- Is there proper ventilation around all sides of the ice machine?
- 7- Has the unit been correctly grounded?
- 8- Is the water to ice maker turned on?
- 9- Is the power to the ice maker switched on?
- 10- Is the unit located in ambient temperature between 40°F and 104°F?
- 11- Is the water temperature between 40°F and 90°F?
- 12- Has the user been fully trained in the operation of the ice machine?

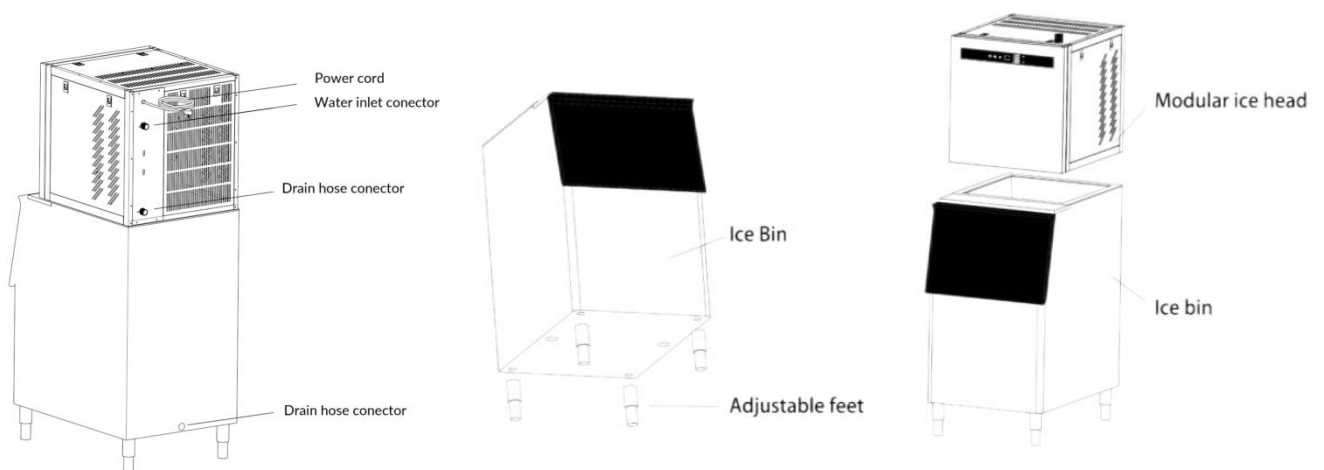

## Operating instruction

Your ice machine features a touch control to operate the controls, please lightly tap the control button with your fingertip. The control panel also features an easy read display which showing the status of the ice machine all times.

## Digital& indicator display and controller

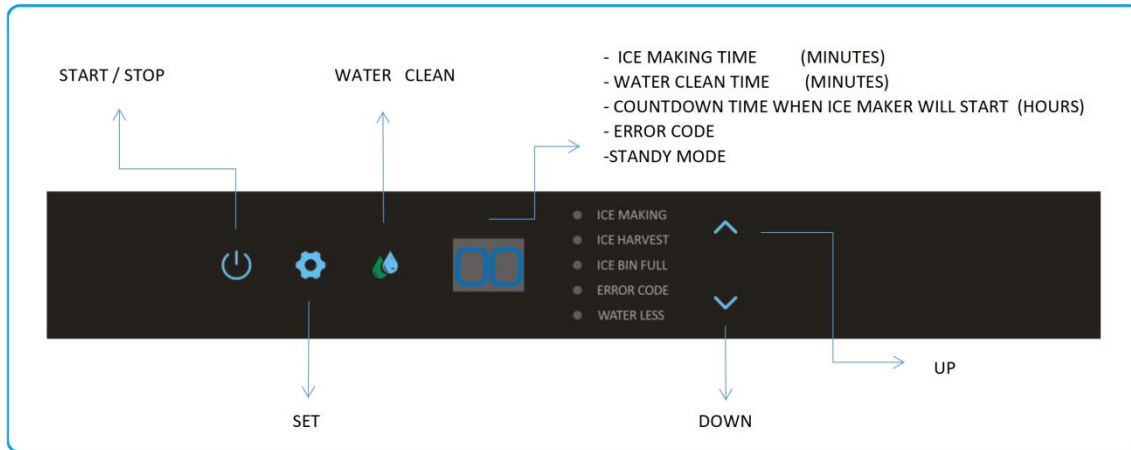

<b>Display</b>	Per Ice making cycle time / Water clean on / Error code / Delay time of resume ice production / Water inlet / Panel locked / Standby status
<b>Indicators</b>	Start & Standby / Set / Water clean / Ice making / Ice harvest / Ice bin full / Error code / water less / Up / Down
<b>Button</b>	Start & standby / Set / Water clean / Up / Down

### **Warning**

After turning off your ice maker, please wait at least 3 minutes before restarting to avoid any damage to the compressor.

**Note:** If a "." appeared on the button right corner of the display window, the ice machine was under locked status.

**Note:** The ice machine will auto-lock if no tap or operation in 30 seconds.

**Un-lock:** Tap the "power" key for 3 seconds to un-lock the control panel before pressing the desired button.



## Ice production

Tap the start/standby button  3 seconds to start ice making, The button will illuminate green and the ice making indicator will illuminate green, ice making time will be display in the digital window.

Water inlet valve, compressor & water pump will start and operate step by step to cool the evaporator to begin to make ice.

**Note:** the ice machine will automatically execute the ice making cycles after plugging and powering up unit.

**Note:** The display window will appear “Co” while water inlet is filling by water valve

**Note:** During the ice making cycle, press the set button  5 seconds, the ice machine will set the harvest cycle immediately.

## Ice harvest

Once the ice production cycle has completed, the machine will switch into the ice harvest cycle, the ice harvest indicator will illuminate blue, then the water pump will stop, and the hot gas bypass valve will energize to release ice from the evaporator. Once the ice harvest cycle has completed, the hot gas bypass valve will turn off and ice harvest indicator will be off.

If the ice bin is not full, the next ice making cycle will begin until ice bin is full.

## Standby

To stop the ice production cycle tap the start/ standby button, the ice machine will return to its standby status, the display window will show “ Off” and the lamp will flash .

If the ice machine has completed the program of “countdown time of delay of resume ice production”, tap the start/standby button to revert from the other program to standby mode , the display window will show the countdown time, set button will illuminate in white and lamp will flash.



**Note:** Tap the start/ standby button to turn off the power of the ice machine. The ice machine must be unplugged and disconnected from the main electrical circuit before any service or cleaning is undertaken.

## Ice full

When the ice bin is full, the ice maker will stop ice production automatically. The ice full indicator lamp will illuminate yellow and  button illuminate in green. “FL” will also be displayed in the digital window.

## Water clean

Tap the clean  button for 3 seconds to start a water cleaning cycle, the clean indicator will illuminate white and “CN” will be displayed in the digital window. Once the cleaning cycle has finished, the ice maker will revert to its standby mode.

Alternately, Press  button for 3 seconds again or  press button during the water cleaning cycle, the cycle will be finished and return to its standby mode or countdown mode immediately.

**Note:** When first starting the ice maker, the system will rinse itself prior to making any ice. The rinsing process takes about 5 minutes.

### How to set the delay and resume ice production

The delay is a key feature that allows the operator to set 0-24 hours delay in ice production. This makes it possible to better manage ice production and lower costs. After the set delay time has passed, the machine will automatically resume ice production.

Tap the set button for 3 seconds, the set button will illuminate white and the start/standby button will flash, the countdown time will be displayed in the digital window. You can touch up/down to increase or decrease the countdown time.

**Note:** Select "00" will not execute the delay program.

After settings has been done, the set button will illuminate white and the start/standby button will flash. The display window will show the countdown time.

**Note:** The set button is not able to set up the countdown time of delay to resume ice production during the ice making cycle.

**Note:** If the ice machine is powered off, or disconnected, the countdown time for the duration for the ice maker to start ice making will be cleared.

### How to set up ice making cycle time

Tap the up / down button , the display window will show the time of per ice making cycle, the time is between 0~45minutes, default time is 16 minutes that can make maximum ice production.

**Note:** The ice machine is only able to set up the time of ice making cycle during the ice making cycle.

 Please do not set the ice making time out of our suggested set times of ice making in different ambient temperatures, otherwise, this may cause ice machine to malfunction.

⚠ Recommended ice production time in different ambient temperature	
Ambient air temperature	Recommended cycle length
<10°C	8 ~12minutes
10 ~14°C	10~15minuts
15 ~24°C	12~20minuts
25 ~34°C	14~25minuts
35 ~42°C	20~30minuts

## **Maintenance & Cleaning**

Periodic cleaning and proper maintenance will extend the life of your ice machine, ensure maximum efficiency and delivery better ice to your customer.

**⚠ Warning:** Disconnect the ice machine from the main electrical and water source before performing and cleaning or any maintenance.

**⚠ Warning:** Inspection, descaling and servicing should only be undertaken by a qualified technician.

**⚠ Warning:** Never clean the ice machine with a pressure washer or by spraying water, and never use any acidic or abrasive detergents.

## **Exterior cleaning**

Always clean the exterior stainless steel surface of the ice machine with a micro-fibre cloth or a sponge. Make sure cleaning is in the direction of the grain of the stainless steel.

**⚠ Warning:** Do not use abrasive or metallic products such as steel wool which could cause corrosion of the stainless steel finish.

**⚠ Warning:** Do not clean plastic components with alcohol or disinfectants as this could cause damage to the plastic components.

## **Air filter cleaning**

The ice machine is equipped with a condenser dust filter to prevent dirt and dust entering the condenser. It is important that the condenser and air filter is cleaned routinely to ensure efficient operation of the machine. **We recommend this procedure is carried out every 15 days.**

**Note:** Push down the buckle at the rear panel of the machine to lift out the panel and remove air filter from the medial side of the rear panel. Clean with a soft brush and vacuum cleaner and replace.

## **Condenser cleaning**

Dirty or clogged condenser will prevent proper air flow. This will lead to reduced efficiency, reduced ice production performance and an increase in operation temperature which may lead to components failure. We recommend that the **condenser is cleaned every six months** by a qualified technician. To clean the condenser, disconnect the ice machine from the main electrical. Push down the buckle at the rear panel of the machine and remove out. Remove dirt and dust from the condenser with soft brush and vacuum cleaner. Reattach the rear panel and reconnect the power to the machine after cleaning.

**⚠Warning:** Failure to clean the condenser could cause component failure and will **VOID** your warranty.

**⚠Warning:** Be careful when doing the condenser cleaning as the edges of the condenser and pins are very sharp.

### **Water distributor, water tank and float switch cleaning**

Minerals, dirt and lime scale that are present in the water during the freezing cycle will build up in the water distributor, water tank and other areas. Cleaning these parts routinely will help to remove the lime scale build up and clean.

We recommend a cleaning such parts every three month with a citric acid soda power solution.

We recommend user implement our water clean program to clean the ice machine every three days.

**⚠Warning:** Dirt & lime scale build up will reduce the efficiency of the ice machine and could lead to the component failure which will **VOID** your warranty.

### **Trouble shooting**

Before calling for service, review the error code, symptoms and recommended solution below, if none of the suggested solution resolve your problem, please contact your local distributor or authorized service company.

<b>Error code</b>	<b>Symptom</b>	<b>Possible cause</b>	<b>Solution</b>
E1	Ice damper or ice full sensor fault	Ice damper dislocation	Check ice damper and ice full sensor, replaced if necessary
		Ice full sensor defective	
Eb	Poor cooling performance	High ambient temperature	Wait until ambient temperature meets requirement
		Poor ventilation	Ensure the sufficient clearance for proper air circulation
		Shortage of refrigerant, inefficient compressor	Check for leak & recharge refrigerant, replace compressor if necessary
		Shortage of water	Check or replace water system components of ice machine and water supply.
		Water temperature sensor inoperative	Check and replace if necessary

		or disconnect.	
		Inefficient compressor	Check the compressor, replace if necessary
E3	Ice harvest overtime	solenoid valve not opening	Check and replace valve if necessary
		Ice making time set too short (ice too thin)	Make sure the set time of ice making cycle is comply with the suggest set time range by manufacturer
		In-sufficient water or water less in water tank	See remedies for shortage of water
E4	Ambient temperature too high	ambient temperature too high	Wait until ambient temperature meets requirement
		Poor ventilation	Make sure the sufficient clearance for air circulation
		Condenser dirty	Clean the condenser
		Condenser fan faulty	Check the condenser fan, replace if necessary
E5	Shortage of Water	Water supply is turn off or no water	Make sure the water supply is turn on and good connect.
		Water pressure too low or water leak	Make sure the water pressure is between 0.2psi to 0.8psi
		Water inlet valve not opening	Check the water inlet valve, replace if necessary
		Water tank leak	Check the water tank, replace if necessary
		Water pump fault	Check the pump, replace if necessary
		Leak of water drain valve	Check the valve, replace if necessary
E6	Out of the pressure limit	Condenser temperature too high	Make sure the sufficient clearance for proper air circulation, Check the pressure of refrigeration system
		Blockage of cooling system	Check the condenser and clean
		Pressure switch fault	Check the switch, replace if necessary
E7	open circuit fail of the condenser sensor	Condenser sensor defective	Check related parts, replace if necessary
		Connector lose or disconnect	

E8	short circuit fault of the condenser sensor	Condenser sensor defective	Check the water temperature sensor, replace if necessary
		Connector lose or disconnect	
E9	open circuit fault of water temperature	Water temperature sensor defective	
		Connector lose or disconnect	
EA	short circuit fault of water temperature	Water temperature sensor defective	
		Connector lose or disconnect	

## Wiring diagram

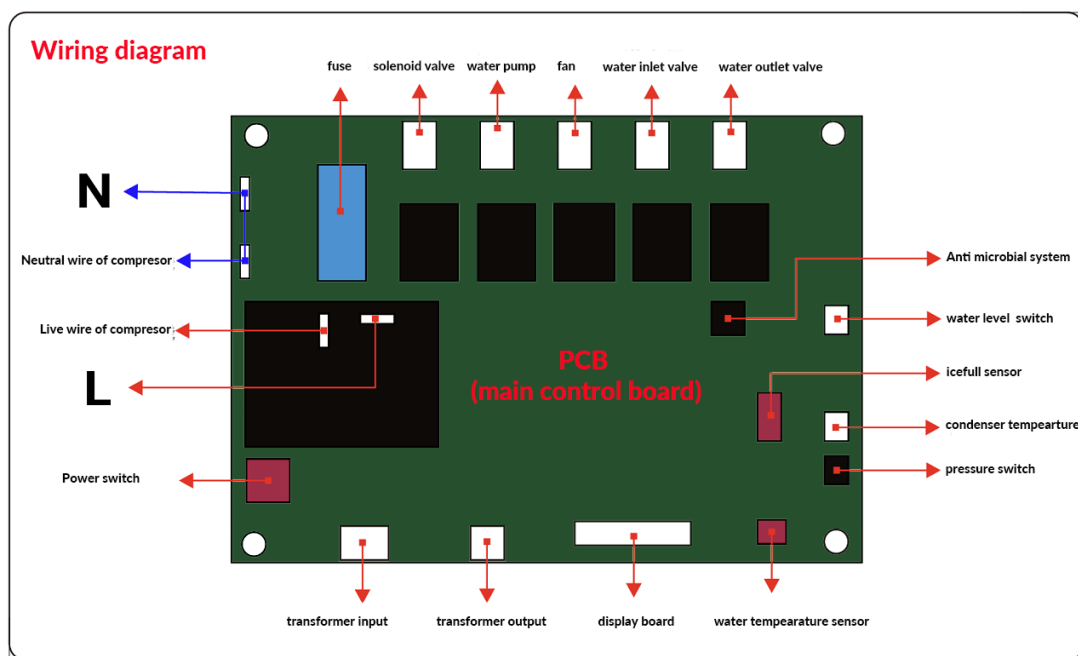



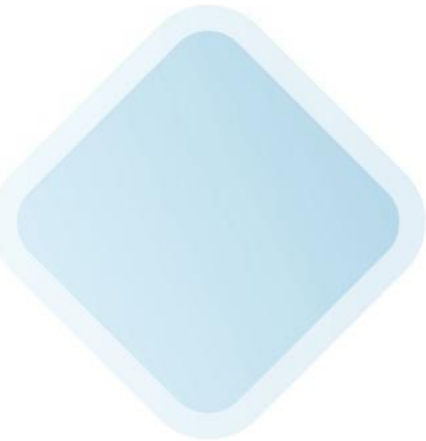

[www.mvpgroupcorp.com](http://www.mvpgroupcorp.com)



3560 NW 56th Street  
Fort Lauderdale, FL 33309  
Tel.: 786.600.4687 / Toll Free: 844.218.8477  
Fax.: 786.661.4100



5659 Royalmount Avenue  
Montreal, Qc, Canada H4P 2P9  
Tel.: 514.737.9701 / Toll Free: 888.275.4538  
Fax.: 514.342.3854 / Toll Free: 877.453.8832

[sales@mvpgroupcorp.com](mailto:sales@mvpgroupcorp.com)